

# 擦窗机器人

## Window Cleaning Robot



■ 高效清洁

Product description  
产品说明书  
User manual

感谢您购买本产品，使用前请仔细阅读说明书

# 目录

目录 .....	1
1. 重要安全事项及警示 .....	2
1.1 注意！使用前必读 .....	2
1.2 安全事项 .....	2
1.3 谨防触电风险 .....	3
1.4 警告 .....	3
2. 产品简介&规格 .....	4
2.1 产品细节 .....	4
2.2 产品参数 .....	5
2.3 产品配件 .....	5
2.4 遥控器 .....	6
3. 操作步骤 .....	6
3.1 连接适配器 .....	6
3.2 连接安全绳 .....	6
3.3 安装抹布 .....	7
3.4 连接电源 .....	7
4. 使用擦窗机 .....	8
4.1 启动擦窗机 .....	8
4.2 停止/暂停 .....	8
4.3 手动模式和自动模式 .....	8
4.4 三种自动清洁模式 .....	8
4.5 清洁完成 .....	9
4.6 不断电系统(UPS)功能 .....	9
5. 产品维护 .....	9
5.1 清洗抹布 .....	9
5.2 擦边传感器维护 .....	10
5.3 行走驱动轮维护 .....	10
5.4 风机维护 .....	10
6. 故障排除 .....	11
7. 保修卡 .....	12

# 1.重要安全事项及警示

## 1.1

### 注意！-使用前必读

1. 请勿让儿童操作本产品，身体、感官或者心理患有疾病的用户和对本产品功能及操作缺乏了解用户必须在熟知使用流程及安全风险后在有完全行为能力的用户监督下使用。儿童不可把此品做为玩具。
2. 本产品仅能用于清洁有框窗户和玻璃(此产品不适用于无边框的窗户和玻璃清洁)。如果窗或玻璃边框的硅胶橡胶边有损坏，请一定特别注意，以防机器在清洁过程中会漏气掉落。用户须对使用场景进行观察，确保产品安全可靠地使用。

## 1.2

### 安全事项

- 请使用原装适配器。使用非原装适配器有可能引发产品故障或者损坏产品。
- 使用中确保适配器有足够空间通风散热。不要用其它物体包裹佳适配器，会增加发热的风险。
- 请不要在潮湿环境中使用适配器。绝对不要用湿手接触适配器。
- 将适配器通电，适配器铭牌上有使用电压标识。
- 请不要使用损坏的适配器，充电线或者插头。对机器进行清理和维护前，请一定将插头断电拔下。不要通过拧脱延长线的方式断电，一定要拔掉电源插头，以防触电。
- 不要拆解适配器。若适配器出现故障，请更换整个适配器。如需帮助和维修，请联系当地客服或者经销商。
- 本品电池若处理不当，有燃烧或者化学灼伤身体的危险。请不要拆解电池、造成电池短路、丢入火中或者在60度以上的环境中使用。
- 请将废旧电池交于当地专业电池电子产品回收中心回收。
- 请保留本说明书以供今后使用。
- 请严格遵照本说明书使用本产品。
- 请勿弄湿本品或者长期置于潮湿环境中，请保持产品远离液体如啤酒、水、饮料等)
- 请勿暴晒本产品，并保持本品远离热源（如散热器、加热器、微波炉、燃气灶炉等
- 请勿将本品置于强磁性场景中。
- 请将本品存放于儿童够不着的位置。
- 产品使用时环境温度：0°C~40°C（32°F~104°F）。
- 请勿清洁破掉的玻璃和表面不平整的物体。在表面不平或者玻璃受损机器将无法产生足够的真空吸力吸附。
- 本品内置电池只能由厂家或者指定经销商/售后中心更换，以免产生危险；废旧电池的处理和回收必须遵守相关国家法律法规执行。
- 拆卸电池或处理电池之前，必须确保机器插头拔掉，电源完全切断。
- 请严格按照使用说明操作本品。厂家不会对因不当使用造成的任何财产损失和人身伤害担负任何责任。

#### 注意！

- 1.必需检查安全绳无破损且一端与机器牢固连接，另一端稳固连接室内其他固定物体，以免掉落伤人或伤物；
- 2.如果窗户的玻璃胶因年久老化出现中间段有脱落、或者四角有缺口等，请谨慎使用并保证机器工作期间用户就在附近以防机器掉落受损或者伤人伤物。

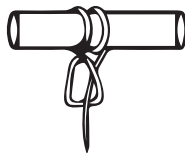

- 在清洁机身或维护机身之前，确保电源完全断开，机器关机。
- 不要通过延长线拖拽电源插头，断电应该正确拔掉电源插头
- 请勿自行对产品进行维修。产品维修必须由授权的售后中心或者经销商进行。
- 若机器损坏/电源损坏，请勿继续使用。
- 机器损坏，请联系当地售后中心或者经销商进行维修。
- 请勿用水清洗机身和电源适配器
- 请勿在如下危险区域使用本品，如有明火、开着喷头流着水的卫生间、游泳池边等，
- 请绝不要毁坏、扭曲电源线。不要将重物压在电源线上或者适配器上，以免引起电源线损坏、火灾或者触电



- 1.操作前.请确保套好安全绳并将安全绳牢固系于稳固的室内装置上.
- 2.开机前，检查安全绳是否有破损，打结是否稳固。确保无破损并打好结以后再使用。
- 3.在清洁无阻台的窗户或门的玻璃时，请在楼下设置安全警示区域。
- 4.使用前将内置备用电池充满电（橙色灯亮）。
- 5.请勿在雨天或者潮湿天气下使用。
- 6.先开机，再将机器置于窗户玻璃上。
- 7.确认机器安全吸助于窗户表面以后再放手。
- 8.关机前，请拿好机器以免掉落。
- 9.请勿用本品清洁无框窗户或玻璃。
- 10.请确保清洁布正确的贴在机器底部，以防机器吸附时漏气。
- 11.不要向机身或者机器底部喷水，喷水只能喷在清洁布上面。
- 12.切勿让儿童使用本机。
- 13.使用前，拿掉玻璃表面所有其它物品。切勿使用本机清洁破裂的玻璃。有些磨砂玻璃有可能会在清洁中被刮伤表面。请谨慎使用。
- 14.请在使用中让头发、松散的服装、手指和身体其它部位与机器的运动部件保持一定的距离。
- 15.请勿在有易燃、易爆固体和气体区域使用。

## 2. 产品简介&规格

### 2.1

### 产品细节

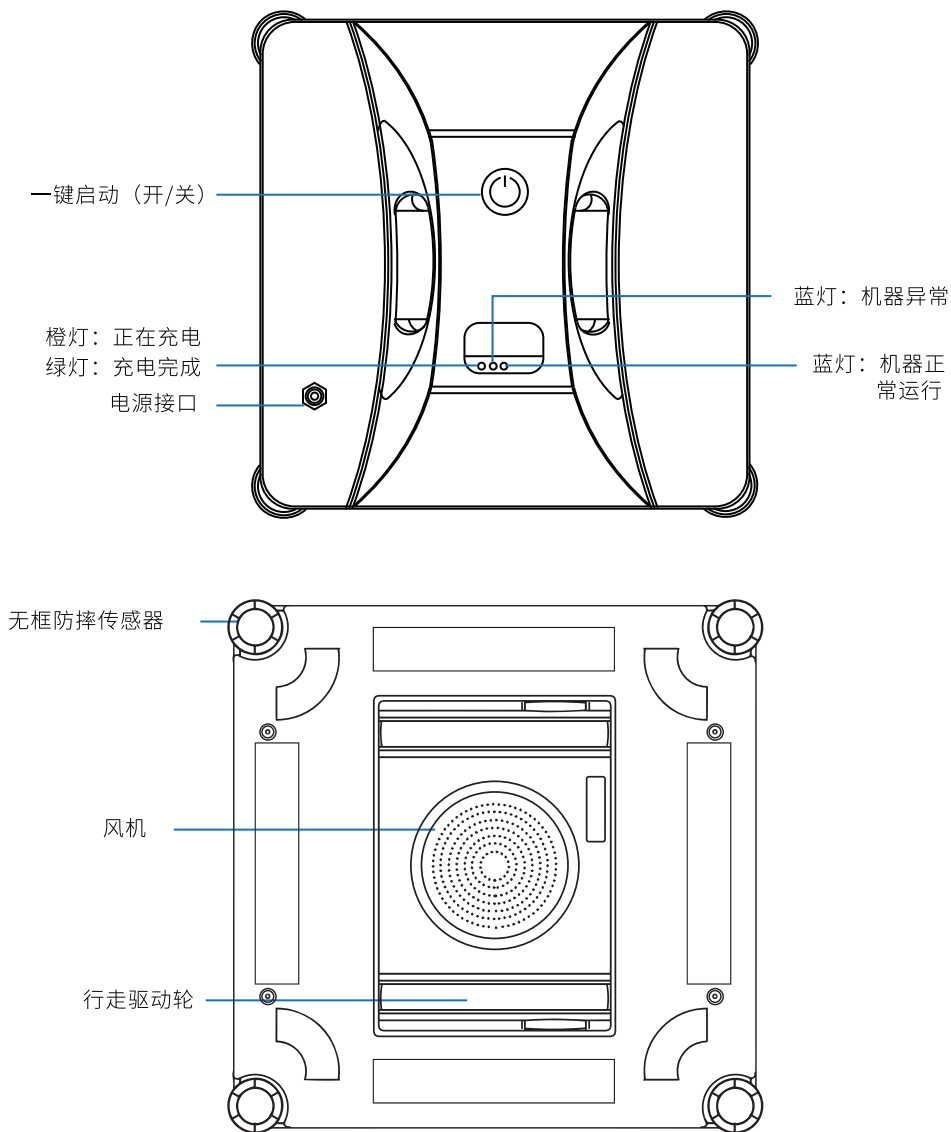

注：本产品因功能不同产品配置略有差异请收到实物为准！

## 2.2

## 产品参数

	输入电压	AC100~240V 50Hz~60Hz
	噪音	65dB
	额定功率	80W
	外形尺寸	250*250*80mm
	电池容量	500mAh
	控制方式	红外遥控器
	净重	1.5KG
	吸力	2800Pa
	无边框探测	自动
	防坠落制控	Ups不间断电源系统/安全绳
	清洁方式	3种

## 2.3

## 产品配件

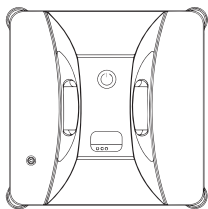

主机

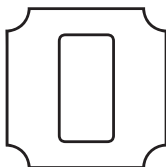

抹布

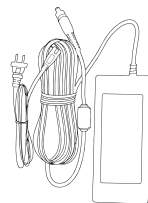

适配器+电源线

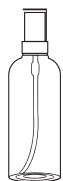

喷水瓶

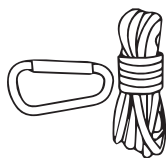

安全绳



遥控器



说明书

 先N再Z路径自动清洁模式	 手动向上移动
 Z型路径自动清洁模式	 手动向下移动
 N型路径自动清洁模式	 手动向右移动
 停止清洁	 手动向左移动
 暂停清洁	 一键启动模式 (默认Z路径)

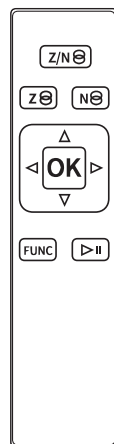

### 3. 操作步骤

#### .3.1

#### 连接电源适配器

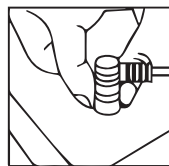
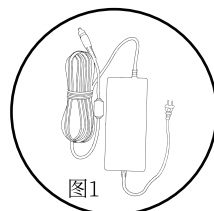
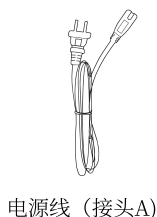
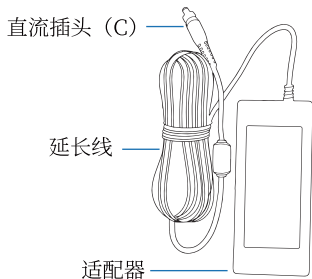

- 将直流插头(接头A)与适配器连接。(图1)
- 将L形接头(接头C)插进机器电源接口处，并拧紧螺母。(图2)

#### 3.2

#### 连接安全绳

- 检查安全绳无破损且与主机的连接是否牢固。(图3)
- 将安全绳另一端固定在室内其他物体上，确保紧固不会掉落。(图4)

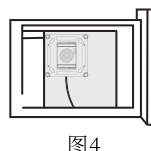
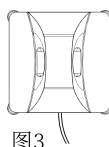

- A. 将清洁剂对准抹布喷5-8次（图5），
- B. 将抹布正确的贴到机身底部，确保不要挡住驱动轮和防摔传感器。（图6）
- C. 抹布安装完成后将水渍擦干。（图7）

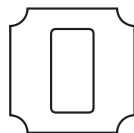

抹布



图5



图6

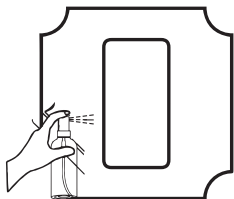

图7

注：请勿完全喷湿抹布

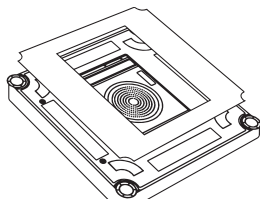
注：安装抹布时，务必不可将抹布覆盖置于机器四角的防摔传感器，覆盖后可能会导致机器掉落。

插入插头，连上机器

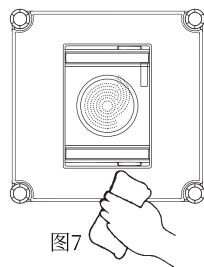
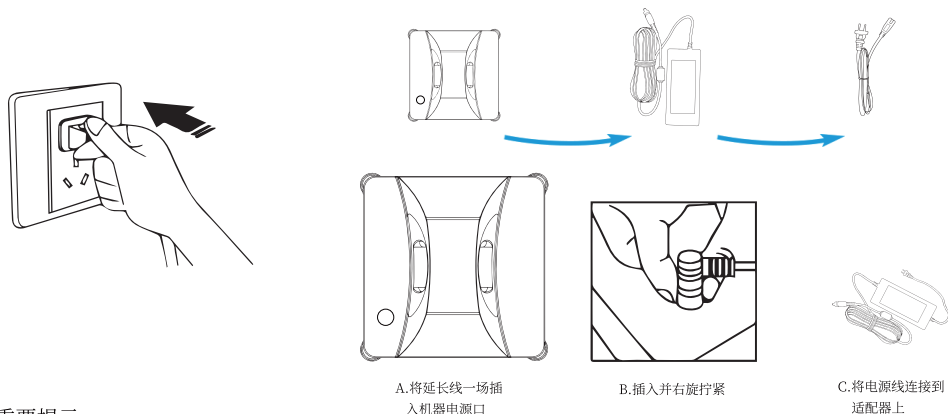



重要提示：

在使用过程中请用交流电源供电。备用电池是为确保机器不会在使用中因突然断电而掉落。仅供使用20分钟。



## 4.使用擦窗机

### 4.1 启动机器人

- A. 长按机身  键2秒可开/关机器的电源。
- B. 把机器置于玻璃表面，按一次  键可启动或者暂停清洁程序。
- C. 您同样可以按遥控器上面的OK键一键启动机器

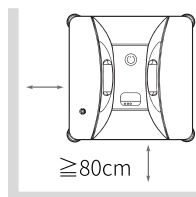



**警示：**启动前，请确保机器人的四边与玻璃框的边框或者窗户四角保持至少8cm的距离。

### 4.2 停止/暂停

- A. 当机器在清洁过程中,按一下  键或者遥控上的FOK按键可停止清洁
- B. 当机器在清洁过程中，按下OK键可暂停/重新清洁。
- C. 同样可以在遥控上按自动清洁/手动清洁模式键再次启动。

### 4.3 自动模式和手动模式

- A. 选择遥控器的三种自动模式 Z/N $\Theta$ 、Z $\Theta$ 、N $\Theta$  自动清洁窗户。
- B. 一键启动模式默认Z路径)
- C. 按  手动操作机器。
- D. 按 **FUNC** 停止清洁
- E. 按  暂停清洁

### 4.4 三种自动清洁模式

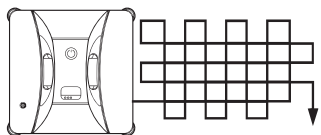

先N再Z模式

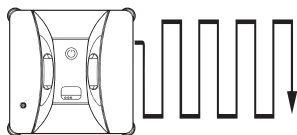

N模式

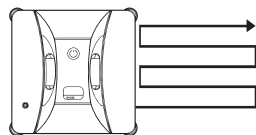

Z模式

擦窗机在完成一次清洁循环后会自动回到开启的位置，清洁完成后蜂鸣器会长响。

A. 使用遥控器将您的机器遥控至方便取下的位置。

B. 抓牢把手，长按开关键2秒关闭电源。

C. 将机器从窗户上取下。

D. 解开安全绳，将机器与其相关配件置于干燥通风环境以备下次使用。

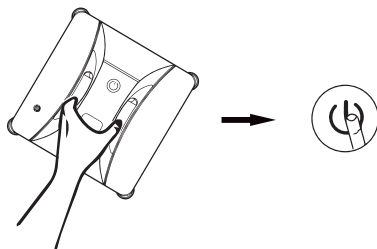

A. 断电时，设备会启动内置电池电源，可持续20分钟。

B. 停电时，机器会停留在原地不继续向前移动，并发出警示声，红/蓝灯交替闪烁。此时，用户应尽快收回机器，避免因断电而从玻璃上坠落。

C. 可使用安全绳轻轻将设备拉回；拉安全绳时，应尽量靠近玻璃，以免坠落。

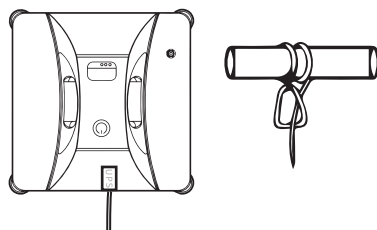

## 5. 产品维护

请将您的机器人机身翻面平放并取下擦布，把擦布放入冷水中，加入少量洗涤剂清洗，用水清洗后晾干后再备用。

注意：

请不要使用完全湿透的擦布清洁窗户，这有可能让您的机器因为过湿吸附在玻璃表面卡住而无法移动。



请将您的机器人机身翻转平放后，用干净的干燥抹布擦除机身底部的灰尘和其它污物。

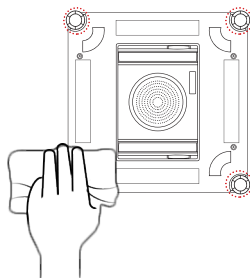

请将您的机器人机身翻转平放，用干净的干燥抹布擦除驱动皮带表面的灰尘和其它污物。展带清洁方法：

- A. 机器连接电源适配器 (无需按开/关键启动机器)。
- B. 连续按遥控器向上键 “▲” 3次，履带转动机器进入履带清洁模式。
- C. 用湿毛巾擦除皮带表面灰尘及污渍
- D. 再次按下遥控器向上键 “▲” 退出履带清洁模式。

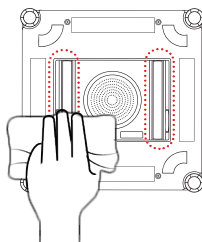

请将机器人机身翻转平放后，用干净的干燥抹布擦除机身底部的灰尘和其它污物。

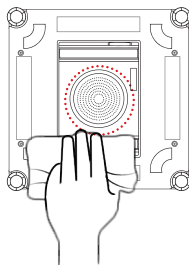

## 6.故障排除

故障状态	可能原因	处理办法
机器打滑	擦布太湿或履带沾水	A.更换机器配备的擦布 B.将沾水的履带上的水用干布擦干 C.清洁履带轮
机器行走不顺	玻璃过于潮湿或玻璃表面带沾性	A.先用遥控器手动(上/下/左/右)各方向将玻璃擦拭一遍，再做进一步操作 B.清洁履带轮
机器运行过程中，顶在玻璃边框不再继续清洁	机器撞边电流误判	A.用遥控器手动遥控到方便操作的位置，再做进一步操作。 B.若遥控器仍无法遥控动作，轻拉安全绳人工将机器移动到方便操作的位置
蓝灯及红灯常亮蜂鸣器不响	机器未贴附于玻璃	将机器吸附于玻璃表面
机器运行过程中蜂鸣器连续响两下	机器探边外传感器感应到移出玻璃边外框信号	无需理会
机器运行过程中机器与玻璃间产生吱吱异响	防摔传感器沾灰过多 履带轮积尘过多	A.喷水给玻璃表面或擦布 B.清理掉附着于防摔传感器上的灰尘 C.清洁履带轮
机器完成擦空动作未停在机器起始放置位	被擦玻璃表面各区域摩擦力不同	将机器用遥控器手动遥控到方便操作的位置
机器在运行过程中在某一位置停止，红灯闪烁	真空不足	A.检查擦布是否安装正确 B.检查玻璃是否有缝隙 C.检查玻璃框是否存在不平整的橡胶
机器无法启动或机器运行过程中未按预设路径规则运作	防摔传感器异常 履带轮积尘过多	A.检查擦布是否安装正确 B.防摔传感器损坏 C.清洁履带轮
蓝灯红灯闪烁，蓝灯不亮蜂鸣器持续叫响	电源断电	检查电源是否断电或机器电源输入接口延长线接口处是否接触不良(紧固螺母未拧紧)
蓝灯红灯快闪蜂鸣器连续间隔1秒响三声	行走电机异常	联系售后服务

\*如按说明书步骤操作机器仍无法正常运行，请联系我售后服务人员以获取帮助。

## 7.保修卡

尊敬的用户：

感谢购买并使用我们的产品！为了保护您的权益。本产品在国家规定的《商品修理更换退货责任规定》(俗称三包)的基础上实行售后服务。为了使我们的服务能让您满意购买请认真读此三包卡并妥善保存。

**产品质量保证说明：**

- 一. 请注意：此三包卡为质保凭证，必须有销售商的加盖印章为有效。
- 二. 服务有效期：自购买之日起生效,即以本凭证记载销售日期。
- 三. 服务内容：
  1. 自购买之日起七日内，包装未损坏，不影响再次销售的产品。
  2. 自购买之日起十五日内，消费者不满意，包换同等价值之产品。
  3. 所购产品在三包期内正常使用和维护下，实行免费维修服务经技术人员检测确认，可免费维修及更换配件。
  4. 报修报换时请务必带齐三包卡，发货票,由销售商负责更投。

四. 下列范围不属于三包服务范围：

1. 超过三包卡有效期的。
2. 未按产品使用说明的要求使用，维护，保管而造成损坏的。
3. 非承担三包的修理者投诉造成损坏的。
4. 无有效三包凭证及有效发票的(能够证明该商品三包有效期)。
5. 擅自涂改三包凭证的。
6. 消费者自行拆除产品底部贴纸之产品。
7. 消费者遗失产品防伪卷标贴纸或产品防伪卷标贴纸破损难辨之。
8. 三包凭证上的产品型号或编号与商品实物不相符的。
9. 因不可抗力(如地震、火灾、水灾)原因造成产品不良或损坏的。
10. 使用盗版软件造成损坏的，或使用过程中感染病毒造成产品损坏的。
11. 人为因素造成之产品不良(如：操作失误、搬运损坏、磕碰、输入不合适电压等)。
12. 其它非产品设计技术、制造、质量等问题而导致的不良或损坏

用户姓名				电话号码		
用户地址和邮编				购机商店盖章		
机器型号						
机器序列号						
附件序列号						
商品产地				发票号码		
购机商品名称						
商店地址和邮编						
商店电话				购机日期		
送修日期	完成日期	用户描述	故障描述	维修记录	维修号码	维修授权签章

备注：

- 1、检查、软件更新不属于维修之列
- 2、只记录三包性能故障表范围内的故障维修

此保修卡请客户妥善保管，以备保修之用





# Window Cleaning Robot



- Efficient cleaning



## Product description

Thank you for purchasing this product, please read the manual carefully before using it.



# Contents

Contents .....	1
1. Important safety instructions and warning .....	2
1.1 Note .....	2
1.2 Safety information .....	2
1.3 Risk of electric shock .....	3
1.4 Warning .....	3
2. Product Description & Parameters .....	4
2.1 Product Description .....	4
2.2 Product parameter .....	5
2.3 Product accessories .....	5
2.4 Use of the remote control .....	6
3. Operation steps .....	6
3.1 Install the power adapter .....	6
3.2 Connect and fix the safety rope .....	6
3.3 Install the wipe cloth .....	7
3.4 Connecting the power supply .....	7
4. Use window cleaner .....	8
4.1 Start the window cleaner .....	8
4.2 Pause/stop .....	8
4.3 Automatic mode and manual mode .....	8
4.4 3 smart path planning modes .....	8
4.5 Cleaning completed .....	9
4.6 Uninterrupted Power failure(UPS)function .....	9
5. Product Maintenance .....	9
5.1 Maintenance of cleaning cloth .....	9
5.2 Maintenance of edge sensor .....	10
5.3 Maintenance of walking drive wheel .....	10
5.4 Fan maintenance .....	10
6. Troubleshooting .....	11
7. Disclaimer of warranties .....	12
8. Product Warranty .....	12
9. Prohibitions .....	12
10. Environment .....	12



# 1. Important safety matters and warnings

## 1.1

## Precautions

1. Do not allow children to operate this product. Users with physical, sensory or psychological disorders, or those who lack knowledge of the functions and operation of this product must be supervised by a fully competent user after being familiar with the use procedures and safety risks. Users must use the product under the supervision of a fully capable user after familiarizing themselves with the use process and safety risks. Children should not use. This product should not be used by children as a toy.
2. This product can only be used to clean framed windows and glass (this product is not suitable for cleaning windows and glass without frames). If the window or glass frame has a damaged silicone rubber edge, please be sure to pay special attention to prevent the machine will leak and fall off during the cleaning process. User must observe the use scenario to ensure that the product is used safely and securely.

## 1.2

## Safety matters

- Please use the original adapter! (Using a non-original adapter may cause product failure or damage the product.)
- Make sure the adapter has enough space for ventilation and heat dissipation during use. Do not wrap the power adapter with other objects.
- Do not use the adapter in a humid environment. Please do not touch the power adapter with wet hands during use.
- Please charge the window cleaner at the voltage that the power adapter can withstand.
- Do not use a damaged power adapter, charging cable or power plug. Before cleaning and maintaining the machine, the power plug must be unplugged and do not disconnect the power by unscrewing the extension cord to prevent electric shock.
- Do not disassemble the power adapter; if the power adapter is faulty, replace the entire power adapter. For assistance and repair, contact your local customer service or distributor.
- This product battery if not handled properly, there is a risk of combustion or chemical dissection injury to the body. Please do not disassemble the battery, so as not to cause a short circuit. Please do not use in fire and high temperature environment above 60°C.
- Please hand over the used battery to the local professional waste battery product recycling center for recycling, the disposal and recycling of used batteries must comply with national laws and regulations.
- Please strictly follow this manual to use this product.
- Please keep this manual for future use.
- Do not immerse this product in liquids (such as beer, water, drinks, etc.) or leave it in a humid environment for a long time.
- Do not expose this product to sunlight and keep this product away from heat sources (such as radiators, heaters, microwave ovens, gas stoves, etc.).
- Do not place this product in a strong magnetic scene.
- Please store this product out of reach of children.
- Please use this product in 0°C-40°C (32°F-104°F) ambient temperature.
- Do not clean damaged glass and objects with uneven surface, this product will not produce enough vacuum suction adsorption on uneven surface or damaged glass machine.
- The built-in battery of this product can only be replaced by the manufacturer or designated dealer / after-sales center to avoid danger.
- Before removing the battery or handling the battery, the power must be disconnected.
- Please operate this product in strict accordance with the instructions, if any property damage and personal injury caused by improper use, the manufacturer is not responsible for any.

### Attention:

1. Before use, please make sure that the safety rope is not broken and one end is firmly connected to the machine and the other end is firmly connected to other. The other end should be securely attached to other objects in the room to prevent the window cleaner from falling and injuring people or objects.
2. If the window glass glue is falling off in the middle section or chipped at the corners due to aging, please be careful to use the machine and make sure it is working during the working period. Please use caution and make sure that there is a user supervising the machine during the working period to prevent the machine from falling down and hurting people or objects.

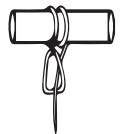

- Make sure the power is completely disconnected and the machine is off before cleaning the body or maintaining the body.
- Do not drag the power plug through the extension cord, power off should be properly unplugged.
- Do not continue to use the product if the machine is damaged/the power supply is damaged.
- Machine is damaged, please contact your local after-sales center or dealer for repair.
- Do not use water to clean the machine body and power adapter.
- Do not use this product in dangerous areas such as open fire, bathroom with water flowing from the open nozzle, by the swimming pool, etc.
- Do not damage or twist the power cord. Do not put heavy objects on the power cord or adapter to avoid damage



1. Before operation, make sure to attach the safety rope and tie it securely to a stable indoor unit.
2. Before turning on the machine, check the safety rope for damage and secure knotting. Make sure there is no damage and that the knot is secure before using the product.
3. When cleaning the glass of a window or door without a blocking table, please set up a safety warning area downstairs.
4. Fully charge the built-in backup battery before use (green light on).
5. Do not use in rainy or wet weather.
6. Turn on the machine first and then place it on the window glass.
7. Make sure the machine is safely attached to the window surface before releasing your hands.
8. Before turning off the machine, please hold the machine to avoid dropping it.
9. Do not use this product to clean frameless windows or glass.
10. Do not use the product to clean frameless windows or glass. Make sure the cleaning cloth is properly attached to the bottom of the machine to prevent air leakage when the window cleaner is adsorbed.
11. Do not spray the machine or the bottom of the machine. Do not spray water on the body or the bottom of the machine, spray water only on the cleaning cloth.
12. Do not allow children to use the machine.
13. Do not use the machine to clean broken glass, some frosted glass may be scratched during cleaning, please use with caution!

## 2.Product Description & Parameters

### 2.1

### product details

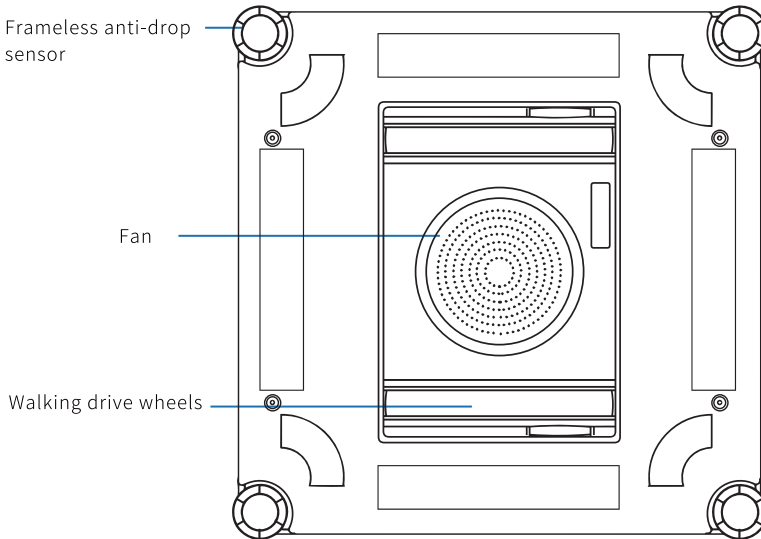
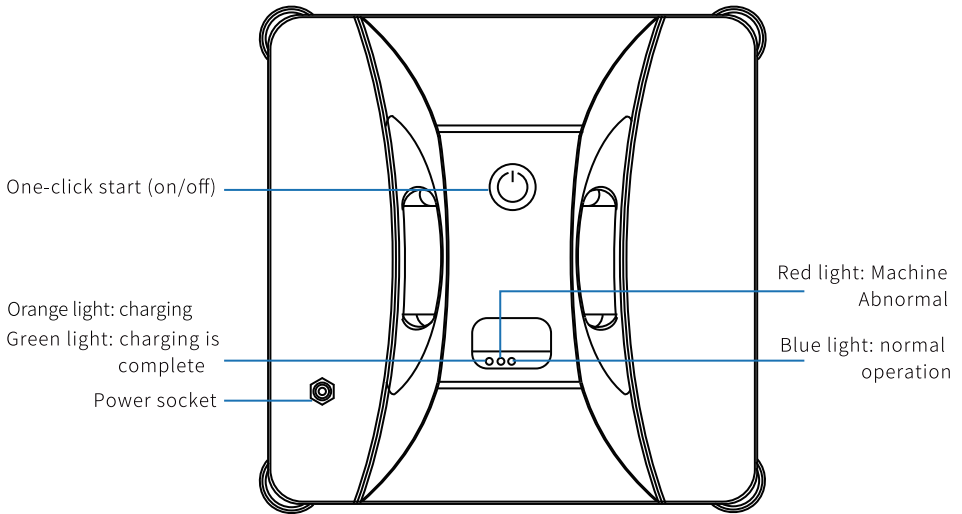

Note: The product configuration is slightly different due to different functions, please receive the actual product!

## 2.2

## Product parameter

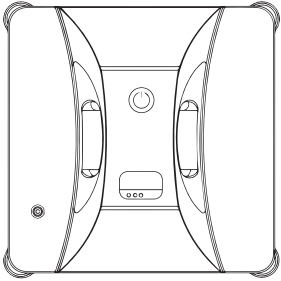
	Input voltage	AC100~240V 50Hz~60Hz
	Noise	65dB
	Rated power	80W
	Dimension	250*250*80mm
	Battery capacity	500mAh
	Control mode	Infrared remote control
	Net weight	1.5KG
	Suction force	2800Pa
	Borderless detection	automatic
	Anti-fall control	Ups uninterrupt power supply system / safety rope
	Cleaning mode	3 kinds

## 2.3

## Product accessories

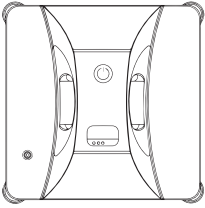

Host

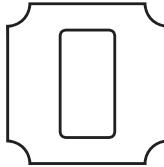

Wipe

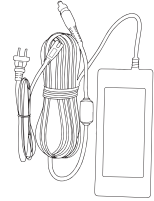

Adapter+Power cord

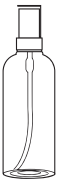

Water spray bottle

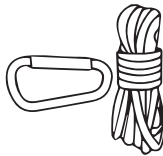









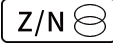

Safety rope



Safety rope



Manual

 Z/N	N and then Z-path automatic cleaning mode		Manual upward movement
 Z	Z-path automatic cleaning mode		Manual downward movement
 N	N-path automatic cleaning mode		Manually move right
 FUNC	Stop Cleaning		Manual move left
 ▶	Stop/ Restart		One button start mode (default “Z” path)

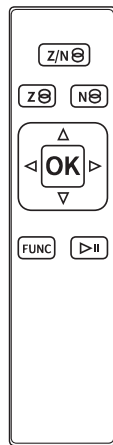

## 3. Installation

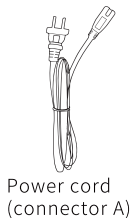
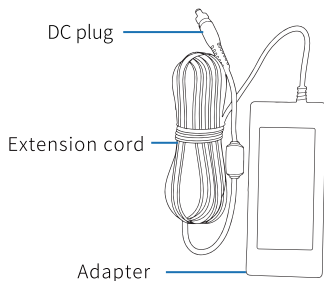

figure 1

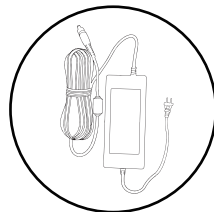
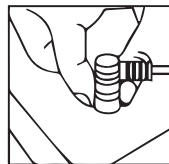

figure 2



- Connect the DC plug (connector A) to the adapter. (figure 1)
- Insert the L-shaped connector (connector C) into the power interface of the machine, and tighten the nut. (figure 2)

- Check that the safety rope is not broken and the connection with the robot is firm. (Figure 3)
- Fix the other end of the safety rope on other objects in the room to ensure that the tightening will not be dropped or fall off. (Figure 4)

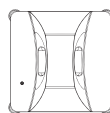

Figure 3

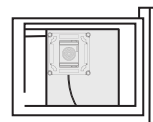

Figure 4



### 3.3

## Install the wipe cloth

- A. Spray the cleaning solution on the rag for 5-8 times (Picture 5),
- B. Attach the rag to the bottom of the fuselage correctly, making sure not to block the drive wheel and the anti-drop sensor. (Image 6)
- C. After the rag is installed, dry the water stains. (Figure 7)

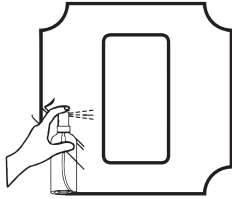

Figure 5

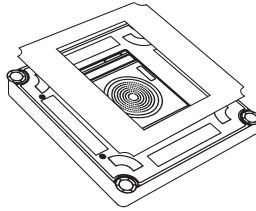
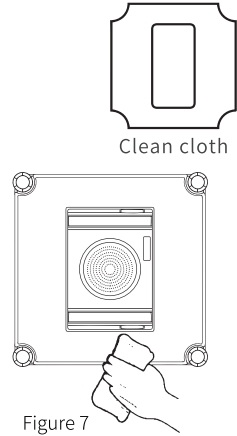

Figure 6



**NOTE:** Do not completely wet the rag

Note: When installing the rag, be sure not to cover the anti-drop sensors placed on the four corners of the machine. The covering may cause the machine to fall.

### 3.5

## Connecting the power supply

Insert the plug and connect to the machine

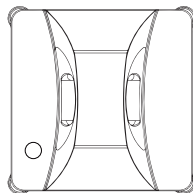
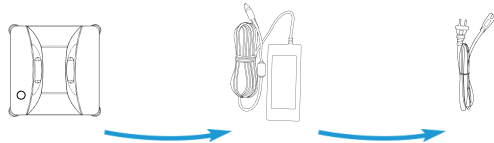
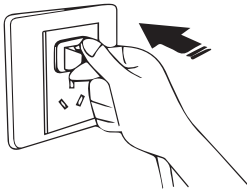

A. Insert the extension cable into the power port of the machine

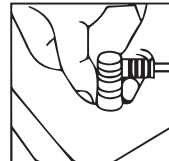

B. Insert and tighten to the right



C. Connect the power cord to the adapter

**Important hint:**

Please use AC power supply during use. Battery backup is to ensure that the machine will not be a sudden falling off during use. For use only for 20 minutes.

# 4. Robot operation

## 4.1 Start robot

- A. Press and hold the "⏻" button for 2 seconds to turn on the machine.
- B. Place the machine on the glass surface to be cleaned and press the "⏻" button again to start the cleaning program
- C. You can also use the "OK" button of the remote control to start the machine.

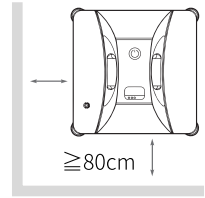

**Warning:** Before starting, please make sure that the four sides of the machine are at least 80cm away from the glass frame or the corners of the window.

## 4.2 Pause/stop

- A. When the machine is cleaning, press the "⏻" button or the OK button on the remote control to stop cleaning
- B. When the machine is cleaning, press the "OK" button to pause/re-clean.
- C. You can also press the auto clean/Manual clean mode button on the remote control to start again.

## 4.3 Automatic mode and manual mode

- A. Select the three automatic modes of the remote control to **Z/N**、**Z**、**N** automatically clean the window completely.。
- B. Press the OK key to stop the machine.
- C. Press to operate the machine manually.
- D. Press **FUNC** Stop Cleaning.
- E. Press Stop/ Restart.

## 4.4 3 smart path planning modes

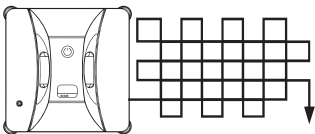

N then Z cleaning mode

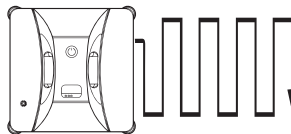

N cleaning mode

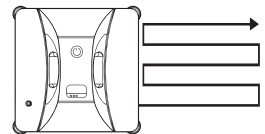

Z cleaning mode

- A. Use the remote control to remote control your window cleaning robot to a convenient position for removal.
- B. Hold the handle firmly and press and hold the on/off button for 1 seconds to turn off the power.
- C. Remove the window cleaning robot from the window.
- D. Pour out the residual cleaning liquid in the tank.
- F. Untie the safety rope and put the window cleaning robot and its related accessories in a dry and ventilated environment for next use.

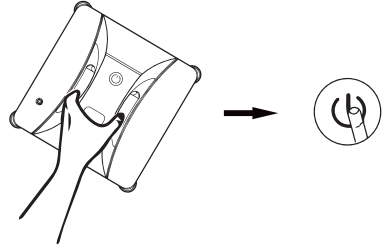

- A. In case of power failure, the device will start the built-in battery power, which can last for 20 minutes.
- B. In case of power failure, the trifoliate orange will stay in the same place and will not move forward, and will give a warning sound and the red / blue lights will flash alternately. At this time, the user should withdraw the machine as soon as possible to avoid falling down due to power off.
- C. The safety rope can be used to gently pull back the device; when pulling the safety rope, it should be close to the glass as far as possible to avoid falling

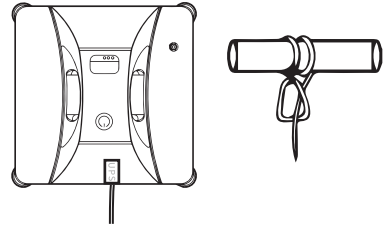

## 5.Product Maintenance

Please turn the body of the robot over and lay it flat and remove the rag, put it in cold water, add a small amount of detergent to clean it, wash it with clean water, and dry it.

Note: Please do not use a completely drenched cloth to clean the windows. This may make your machine stuck on the glass surface due to excessive moisture and cannot be moved





## 5.2

## Maintenance of edge sensor

Please turn your robot over and lay it flat, then use a clean, dry cloth to wipe off any dust and other dirt from the bottom of the robot.

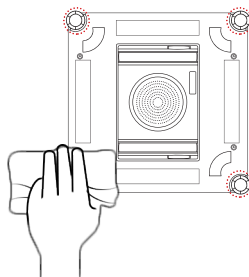

## 5.3

## Maintenance of walking drive wheel

Please turn your robot body flat and use a clean, dry rag to wipe dust and other dirt from the drive belt surface.

How to clean the spreading belt:

Connect the power adapter, press the upward "▲" button on the remote control for 3 times continuously when the power is off, turn the belt, and wipe the dust on the surface of the belt with a wet towel. Press the up "▲" button again to stop rotation.

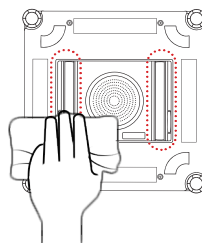

## 5.4

## Fan maintenance

Please turn your robot over and lay it flat, then use a clean, dry cloth to wipe off any dust and other dirt from the bottom of the robot.

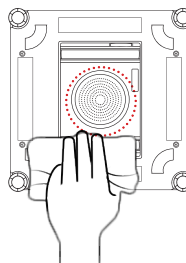

# 6.Troubles hooting

Fault status	Possible causes	The solution
TMachine slippage	Wiping cloth is too wet or the track is stained with water	A.Replace the wiping cloth equipped with the machine B.Dry the water on the track with a dry cloth C.Clean the track wheel
The machine is not running smoothly	The glass is too wet or the glass surface with staining	A. First use the remote control manually (up/down/left/right) in each direction to wipe the glass once, and then do further operations B. Clean the track wheel
During the operation of the machine, the top in Glass over the frame no longer continue to clean	The machine hit the edge of the currentmisjudgment	A. Use the remote control to manually remote control to a convenient operating position, and then do further operations. B. If the remote control is still unable to remote control the action, lightly pull the safety rope to manually move the machine to a convenient operating position .
Blue light and red light is always on buzzer does not sound	The machine is not attached to the glass	The machine is not attached to the glass
The buzzer sounds two times in a row during the operation of the machine	The machine probes the edge of the outside sensor senses the signal to move out of the glass edge frame	Ignore
Machine operation process between the machine and the glass squeaking noise	Anti-drop sensor dust too much dust accumulation in the track wheel too much	A. Spray water to the glass surface or wipe the cloth B.Clean off the dust attached to the anti-drop sensor C.Clean the crawler wheel
The machine has not stopped at the starting position of the machine after the wiping action	The friction force of each area of the wiped glass surface is different	Attaching the machine to the glasssurface
The machine stops at a certain position in the process of operation, and the red light flashes	Insufficient vacuum	Check whether the wiping cloth is installed correctly
The machine stops at a certain position in the process of operation, and the red light flashes	The anti-drop sensor is abnormal and the track wheel accumulates too much dust	A. Check whether the wipe is installed correctly B. The anti-drop sensor is damaged C. Clean the track wheel
Blue light red light flashing, blue light does not light the buzzer continues to buzz	Power supply power failure	Check whether the power supply is disconnected or the machine power input Interface extension cable interface for poor contact (tightening nut is not tightened)
blue light red light flashing buzzer continuous interval of 1second sound three	Abnormal walking motor	Contact after-sales service

\*If the machine still cannot operate normally according to the manual, please contact my after-sales service staff for help.

## 7.Disclaimer of warranties

The manufacturer makes no representations or warranties, either express or implied.

The manufacturer makes no representations or warranties, express or implied, and specifically disclaims any warranties with respect to the contents of this manual.

The manufacturer makes no representations or warranties, express or implied, regarding the contents of this document and specifically disclaims any warranties, merchantability, or fitness for any particular purpose. In addition, the manufacturer reserves the right to revise this publication and to make changes to the contents at any time.

In addition, the manufacturer reserves the right to revise this publication and to make changes to its contents from time to time without any obligation on the part of the Company to notify any person of such revisions or modifications. The Company is under no obligation to notify anyone of such modifications or changes.

The place and safety of use of this glass cleaning tool must be at the discretion and responsibility of the user.

However, it is also necessary to follow the instructions in this user manual.

## 8.Product Warranty

If your cleaning robot is defective during the warranty period due to defective materials, defective workmanship or defective function.

If your WIPPER glass cleaning robot develops a problem due to a defect in material, workmanship or function within the warranty period from the date of purchase or delivery.

Please contact your local retailer or local authorized dealer for repair or replacement.

## 9.Prohibitions

- This warranty will automatically expire and will not apply to any product purchased.
- This warranty will automatically void and does not apply to any product purchased if.
- Normal wear and tear (e.g., cleaning cloths, safety harnesses, etc.)
- Reduced battery discharge time due to aging or use of the battery
- Damage due to failure to assemble or install in accordance with the manufacturer's instructions
- Damage caused by not assembling or installing in accordance with the manufacturer's instructions.
- Damage caused by using the glass cleaning robot for any other purpose.
- Damage caused by using the Glass Cleaning Robot for purposes other than normal household use.
- Damage caused by the use of parts and accessories not specified by the manufacturer.
- Damage caused by accident, abuse or misuse.

## 10.Environment



The symbol on this equipment indicates that this equipment is not to be disposed of as household waste.

The symbol on this equipment indicates that this equipment is not to be disposed of as household waste. Instead, it must be given to the applicable collection point for recycling of electrical and electronic equipment.

Waste must be disposed of in accordance with local environmental regulations.



This appliance complies with the European Directives 2014/30/EU, 2014/35/EU, and 2014/53/EU  
Subject to change without notice.

